

Varenummer: 207321M685NI  
Beskrivelse: E+G Pasbolt  
GN 732.1-M6-8-5-NI

## Mål

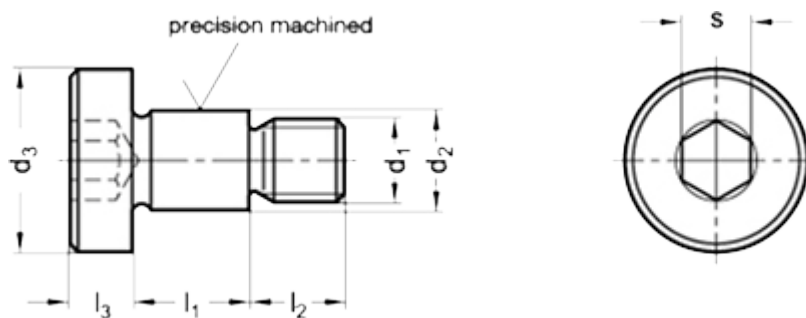

### Application example



d1	= M 6
d2	= 8 -0.05/-0.08
d3	= 14
l1 +0.20/+0.13	= 5
l2	= 8
l3	= 4
s	= 4
Vægt i (g)	= 8